

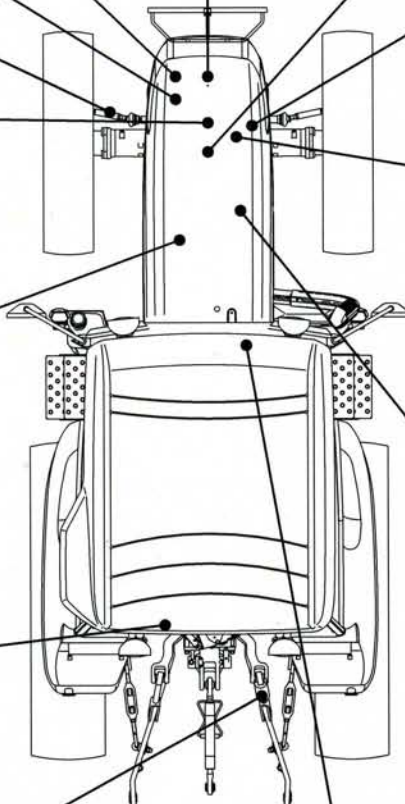

## MZ60 SMZ76, SMZ85, SMZ90 曳引機

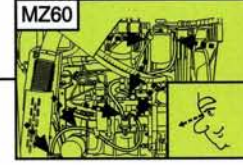
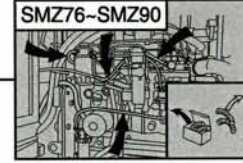
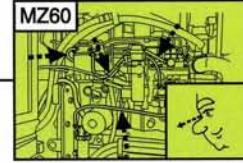
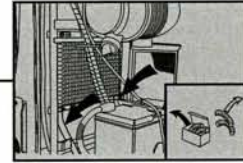
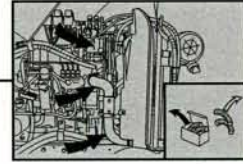
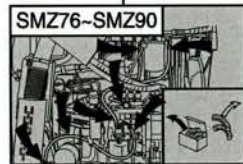
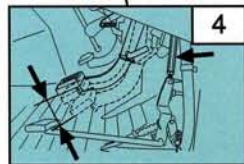
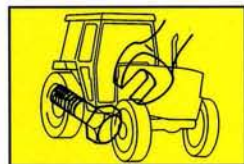
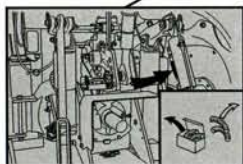
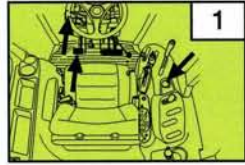
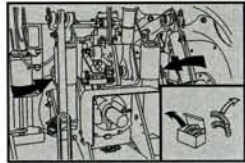
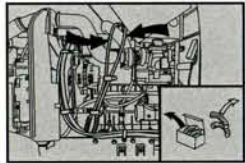
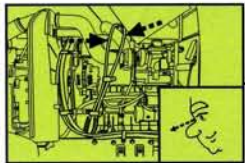
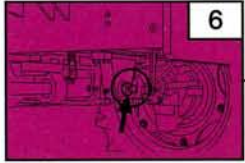
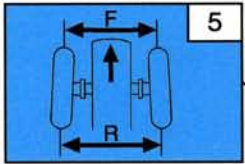
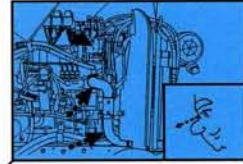
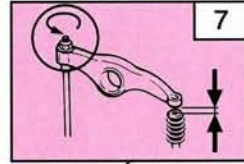
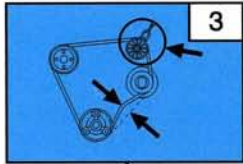
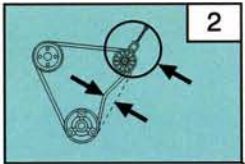

| No. | 項目             | 機型        | 出廠標準   |       |       |       |
|-----|----------------|-----------|--|-------|-------|-------|
|     |                |           | MZ60   | SMZ76 | SMZ85 | SMZ90 |
| 1   | 引擎起動系統         |           | 1. 坐在駕駛座上，將梭動桿置於[中立](N)位置，將PTO離合器控制開關置於[OFF](切)。<br>2. 拉上停車剎車，停止引擎。<br>3. 將加速桿置於[最低速]。<br>4. 將離合器踏板踩到底、鑰匙開關置於[起動]位置。<br>此時，如果引擎轉動，則表示正常。<br>5. 然後，將梭動桿置於[前進](F)或[後退](R)，或將PTO離合器置於[ON](入)，再將鑰匙開關置於[起動]位置。<br>此時，如果引擎不轉動，則表示正常。 |       |       |       |
| 2   | 風扇皮帶的緊度        |           | 用指尖以大約98N(10kgf)的力按下皮帶的中央部，將皮帶的緊度調整為7mm左右。   |       |       |       |
| 3   | 空調皮帶的緊度        |           | 用指尖以大約98N(10kgf)的力按下皮帶的中央部，將皮帶的緊度調整為10~12mm左右。   |       |       |       |
| 4   | 剎車踏板的遊隙        |           | 踏板上為 35 ~ 45 mm  |       |       |       |
| 5   | 前束量            |           | 2 ~ 8 mm   |       |       |       |
| 6   | 前部差速箱<br>前後的遊隙 | 調節螺栓的鎖緊扭矩 | 2.0 ~ 3.0 kgf·m  |       |       |       |
|     |                | 鎖緊螺帽的鎖緊扭矩 | 10 ~ 15 kgf·m  |       |       |       |
| 7   | 閥間隙            |           | 0.23 ~ 0.27 mm   |       |       |       |